

Minipret.nl

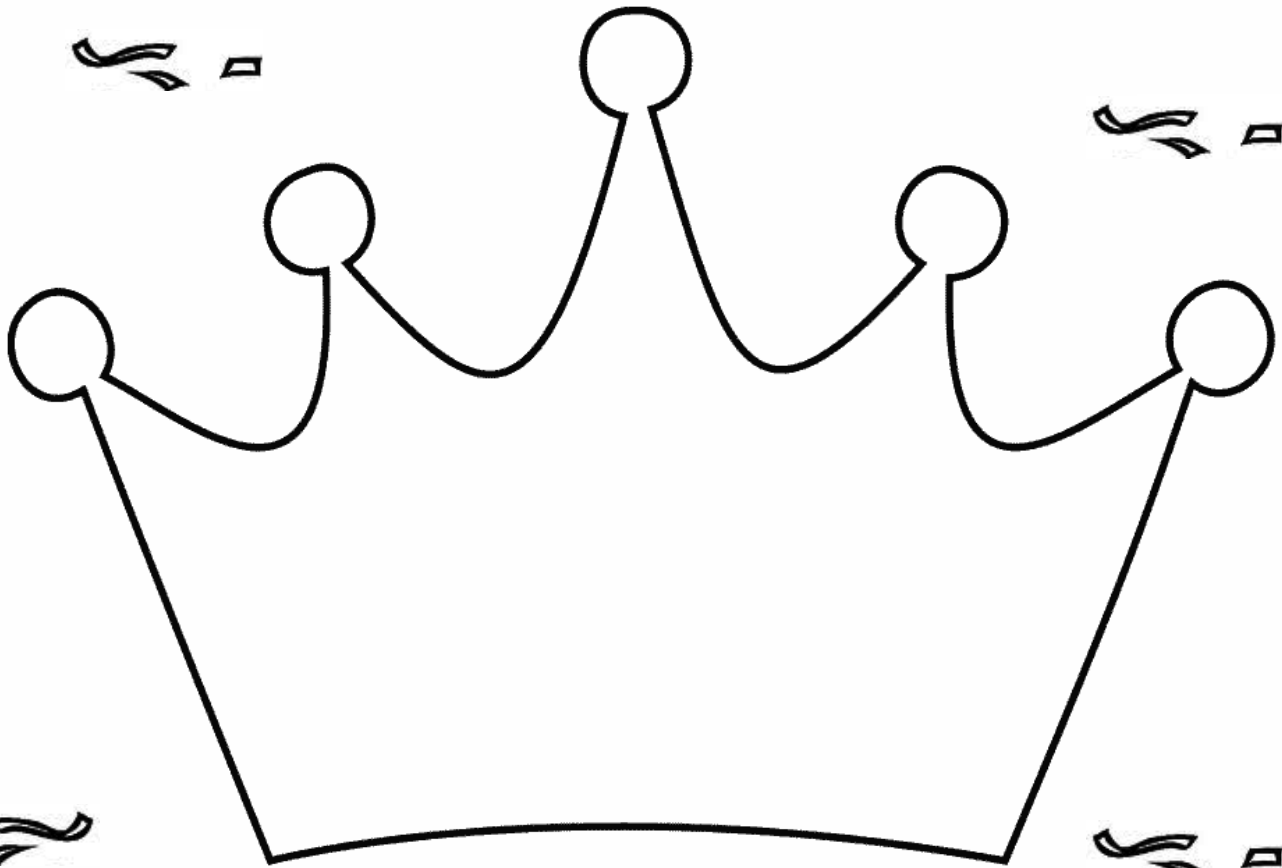

Koningsdag

Werkboekje Groep 3-4

Naam: _____ Groep: _____

Doolhof

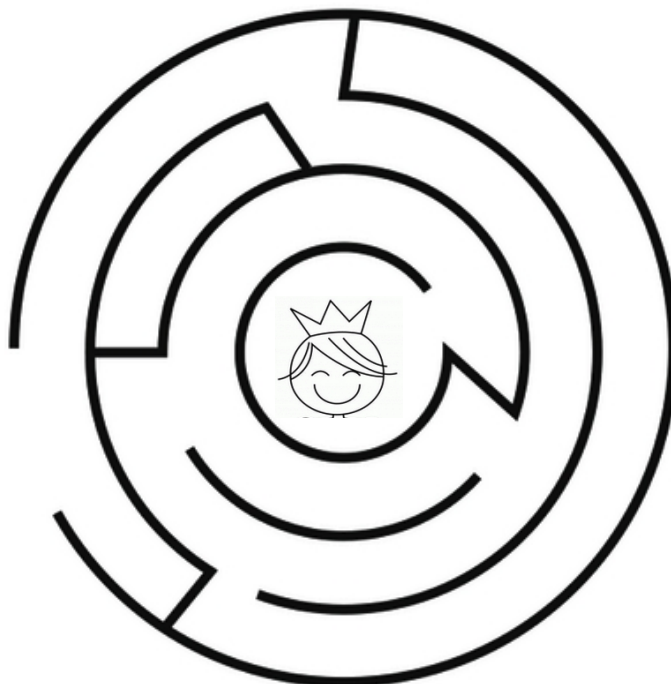
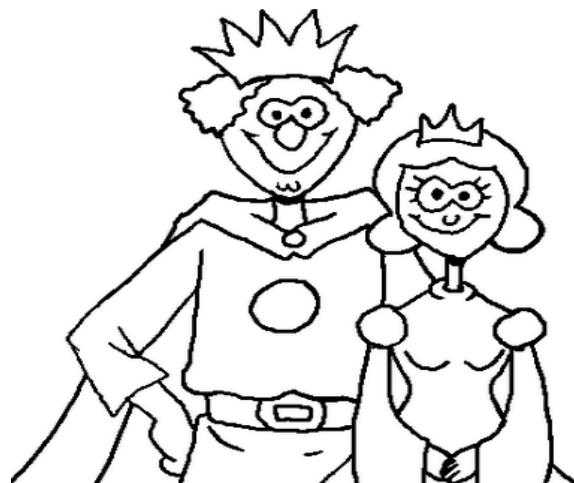

Woorden zoeken

Verbind dezelfde woorden met elkaar.

Feest

Amsterdam

Koning

Prinses

Amalia

Ijs

Amsterdam

Confetti

Prinses

Feest

Confetti

Koning

Ijs

Amalia

Maak de Nederlandse vlag!

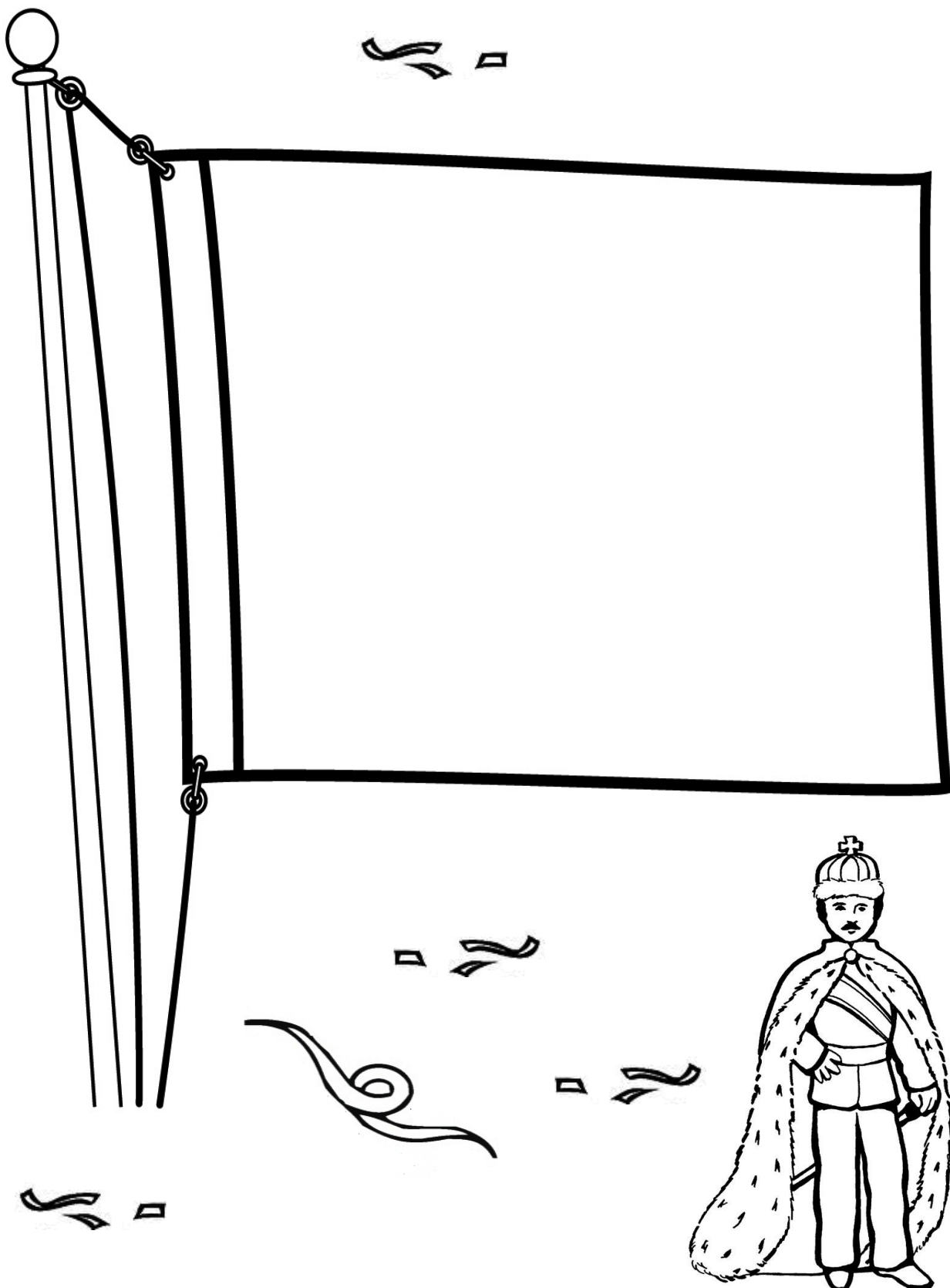

Kleurplaat

Kleur de prinses hieronder zo mooi mogelijk in.





Verbinden



Verbind het juiste plaatje met het juiste woord.

Vlag . .



Troon . .



Kroon . .

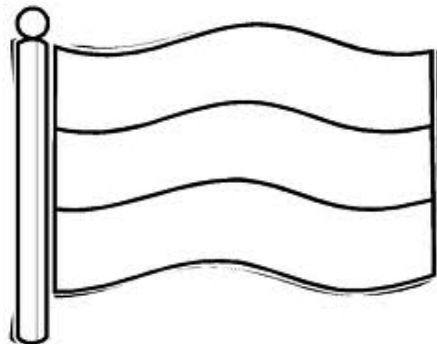

Koning . .



Kleurplaat

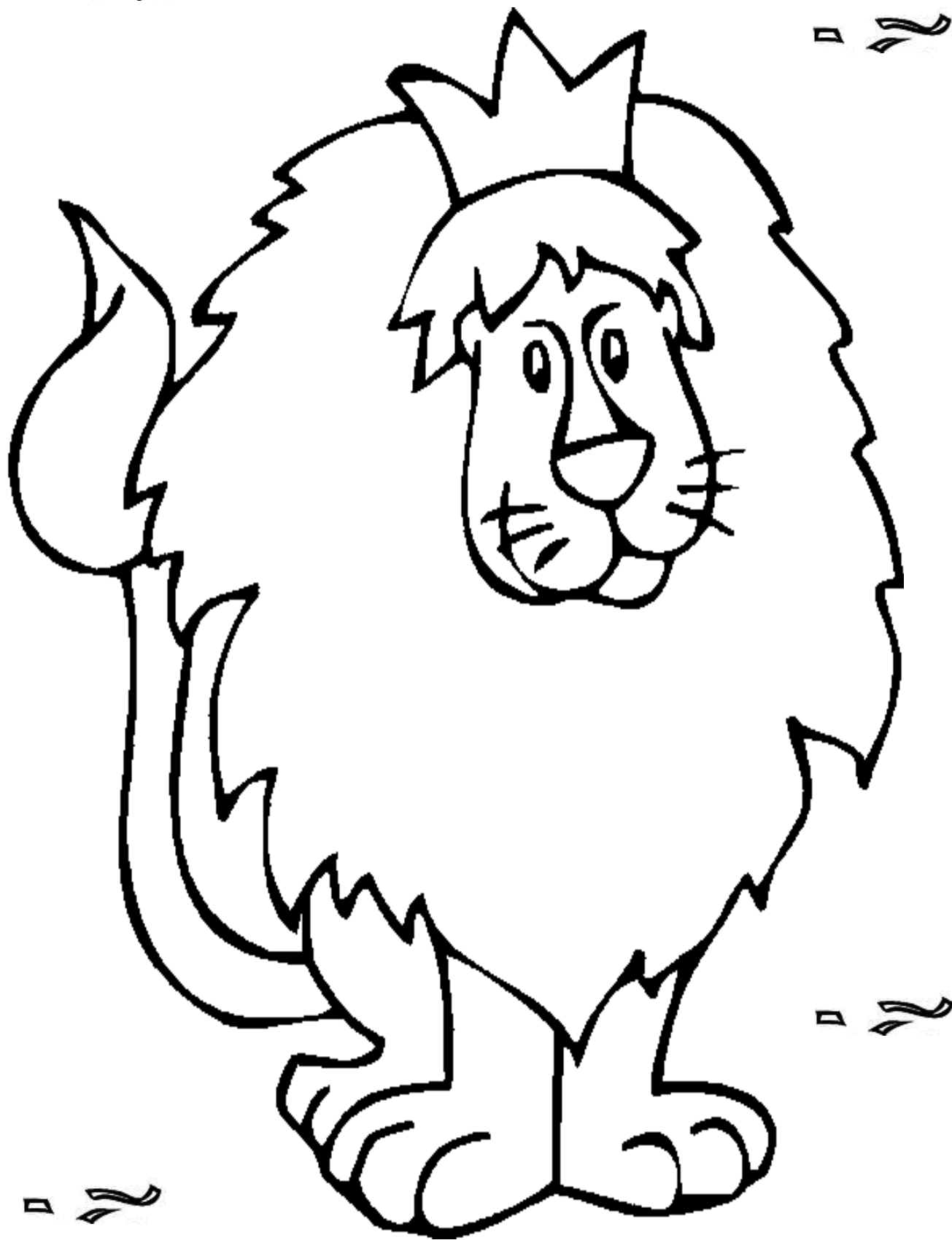



Tellen



De koning wil weten hoe goed jij kan tellen.
Schrijf zoveel mogelijk getallen op.

- | | | |
|----------|----------|----------|
| 1 | 13 | 25 |
| 2 | 14 | 26 |
| 3 | 15 | 27 |
| 4 | 16 | 28 |
| 5 | 17 | 29 |
| 6 | 18 | 30 |
| 7 | 19 | 31 |
| 8 | 20 | 32 |
| 9 | 21 | 33 |
| 10 | 22 | 34 |
| 11 | 23 | 35 |
| 12 | 24 | 36 |

Teken de Koning

Kleur de troon en teken er een koning bij.

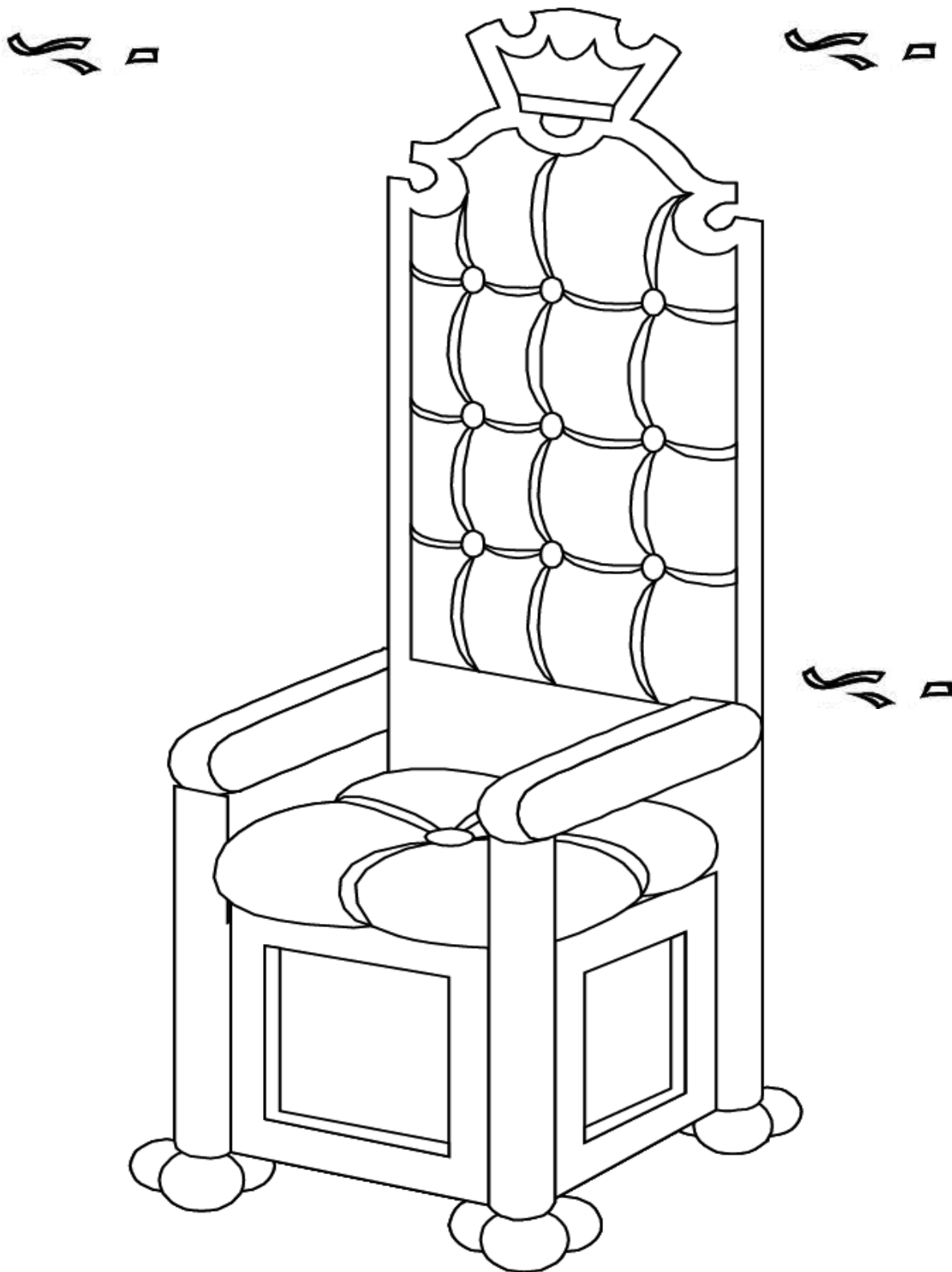



Rekenspelletje



De koning en koningin zijn gek op spelletjes.
Kan jij ze helpen met deze sommen?

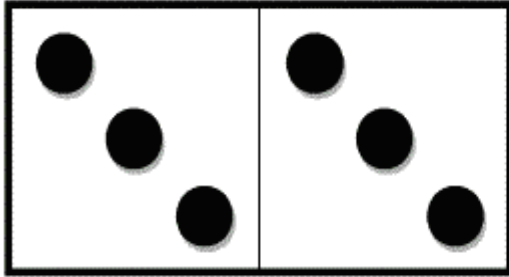

$$\underline{\quad} + \underline{\quad} = \underline{\quad}$$

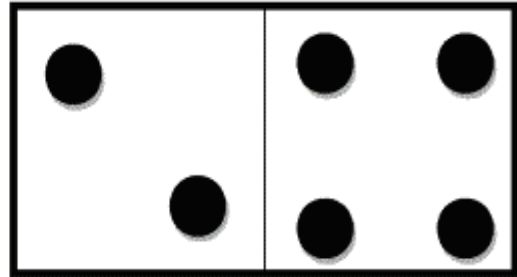

$$\underline{\quad} + \underline{\quad} = \underline{\quad}$$

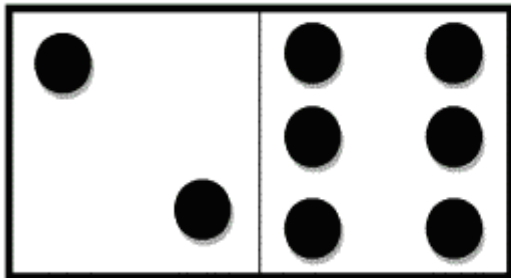

$$\underline{\quad} + \underline{\quad} = \underline{\quad}$$

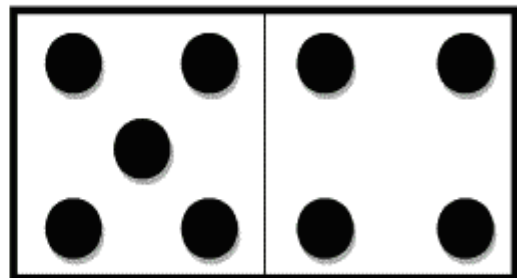

$$\underline{\quad} + \underline{\quad} = \underline{\quad}$$

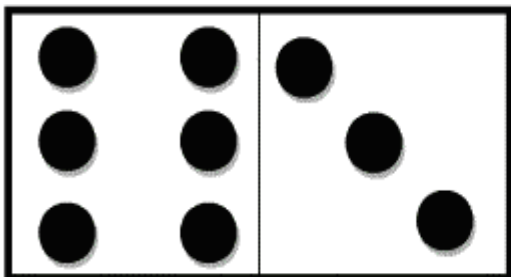

$$\underline{\quad} + \underline{\quad} = \underline{\quad}$$

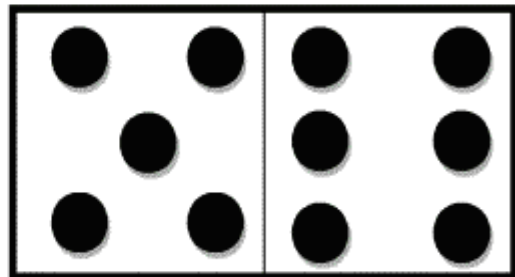

$$\underline{\quad} + \underline{\quad} = \underline{\quad}$$

KONINGSDAG

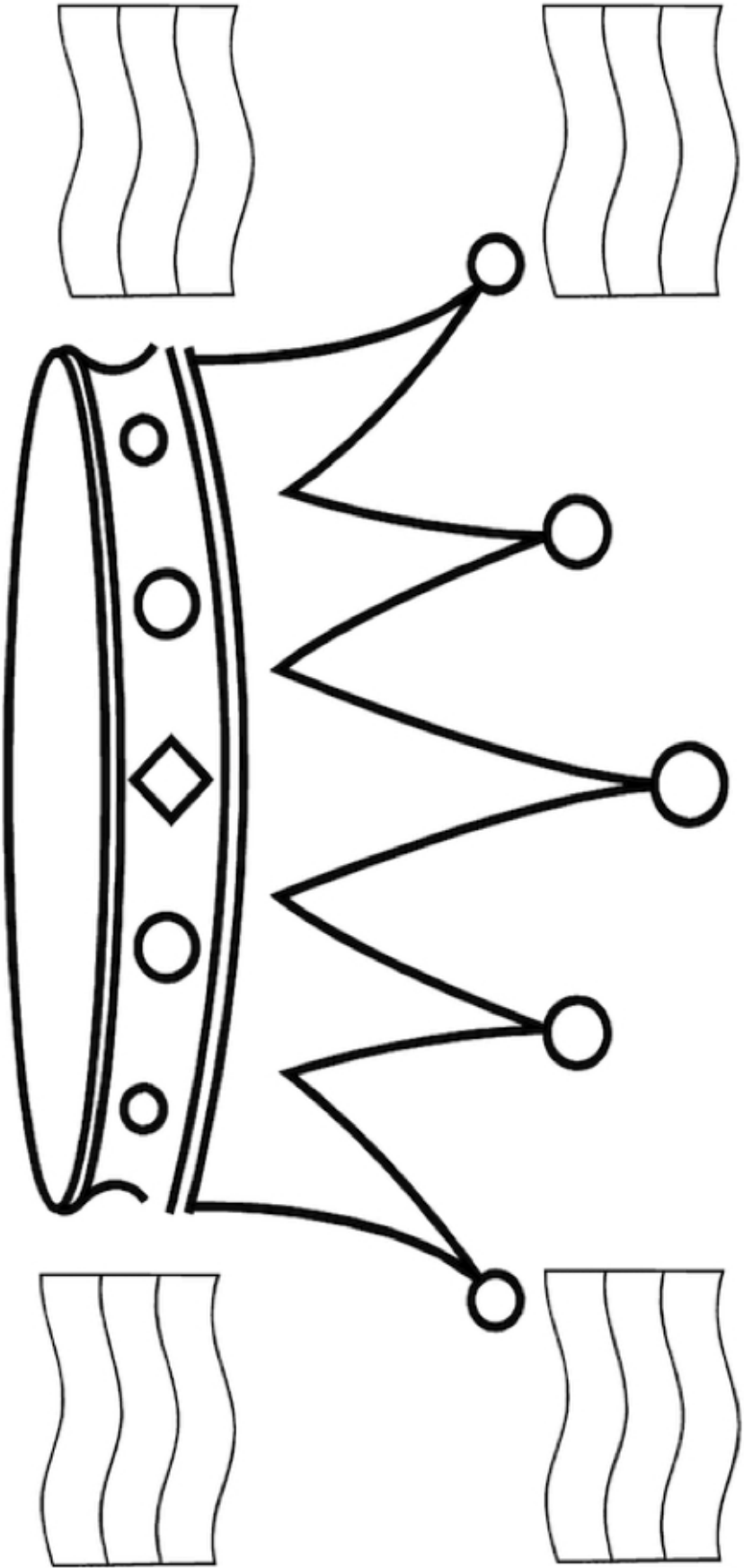

Speel Koningsdag Spelletjes

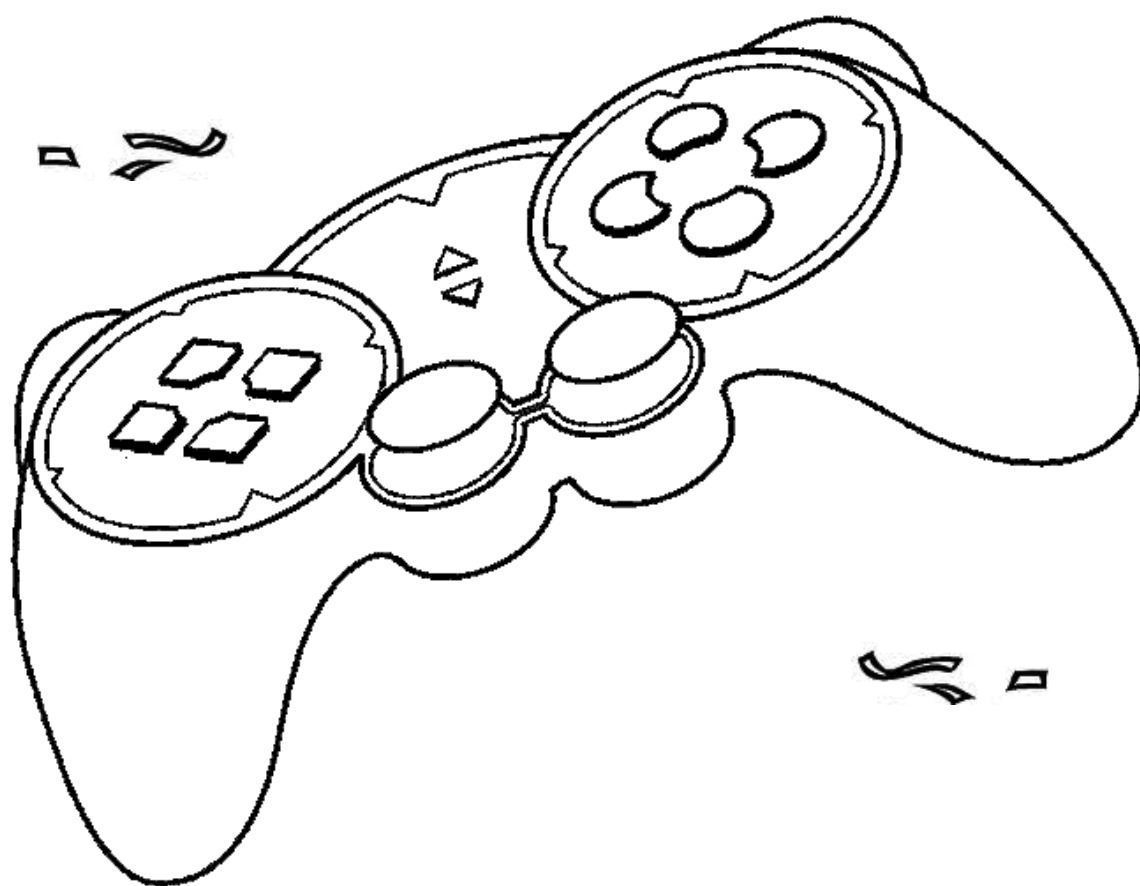

www.minipret.nl